

KFC-W108

SERVICE MANUAL

KENWOOD





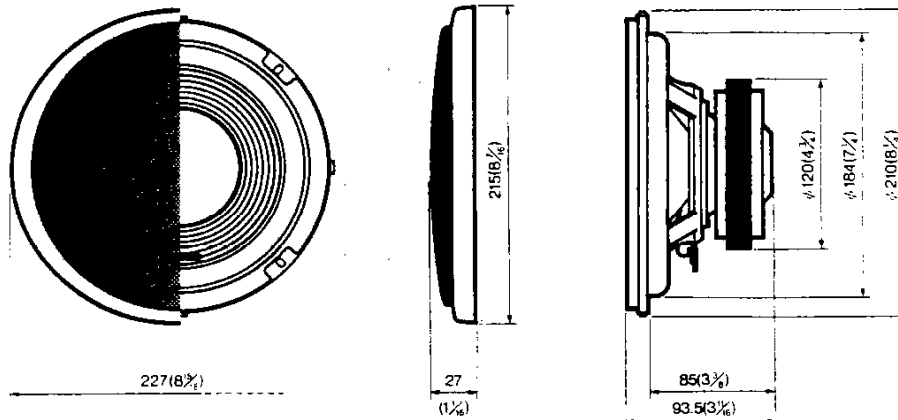

© 1987-12 PRINTED IN JAPAN
B51-3424-00 (G) 1855

EXTERNAL VIEW



Unit: mm (inch)

PARTS INCLUDED

-  $\phi 4 \times 40$ ($\phi 3/16 \times 19/16$)..... × 8
-  × 8
-  $M4 \times 70$ ($\phi 3/16 \times 2-3/4$)..... × 8
-  $\phi 4$ (3/16)..... × 16
-  $\phi 4(3/16)$ × 8
-  $M4(\phi 3/16)$ × 16

PARTS LIST

★ New parts
Parts without **Parts No.** are not supplied.
Les articles non mentionnes dans le **Parts No.** ne sont pas fournis.
Teile ohne **Parts No.** werden nicht geliefert.

New Parts	Parts No.	Description
★	B06-0279-08 B46-0100-10	FRONT GRILLE WARRANTY CARD
★	N99-1065-08	SCREW SET
★	T10-0355-08	SPEAKER (WOOFER)

SPECIFICATIONS

- Speaker..... 200mm(8in)
cone type 25.4oz magnet
- Peak input power..... 300 Watts
- Sensitivity..... 89dB/W at 1m
- Frequency response..... 45Hz to 2.000Hz
- Resonant frequency (fo)..... 30Hz
- Impedance..... 4 ohms
- Weight per speaker with grille.... 2.2kg (4.9lb)/pc

We follow a policy of advancements in development.
For this reason specifications may be changed without notice.

Q.C.
COPY